

**FAMOUS
TOLEDO**

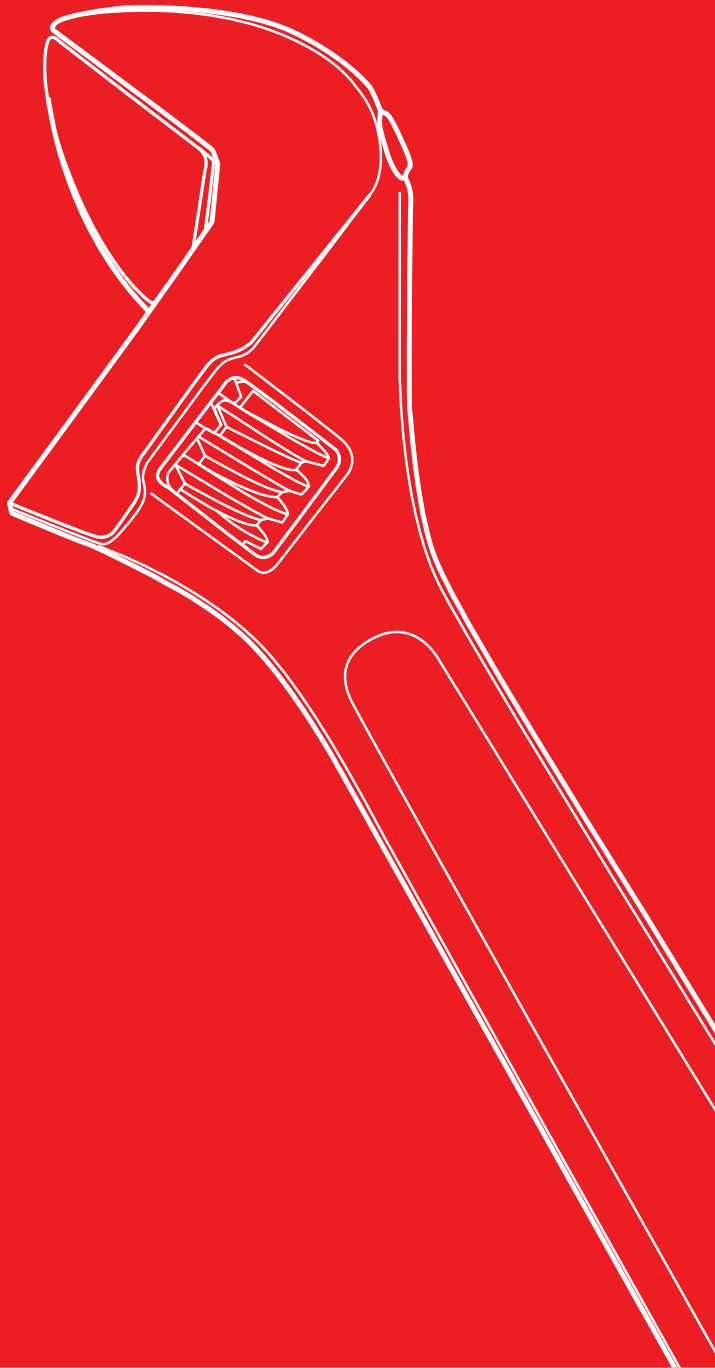

Air Tools

Banding & Cutting Tools

Clamping & Vices

Cleaning Tools

Component Identifiers

Cylinder Honing Tools

Diagnostics

Feeler Gauges

Hose Tools

Keys & Bits

Pick-Up Tools

Pipe Tools

Pry Bars

Scraping & Marking

Screwdrivers

Sockets

Spanners & Wrenches

Striking Tools

Thread & Bolt Tools

Tool Organisers

General

WORKSHOP TOOLS





WORKSHOP TOOLS

AIR TOOLS

Air Blow Guns

- Handy and reliable units for air cleaning work areas and equipment etc.
- Trade quality items that provide maximum air output with minimal noise
- Ergonomic design for extended use without fatigue
- Fast, simple, safe and economical

Air Blow Guns Angle Nozzle - Trigger Style

- Round edge modern design provides a comfortable grip for superior manoeuvrability
- Available in 100mm and 280mm nozzle lengths
- 1/4" NPT inlet and handy built in hanger slot
- Manufactured from high impact plastic for maximum quality and longevity

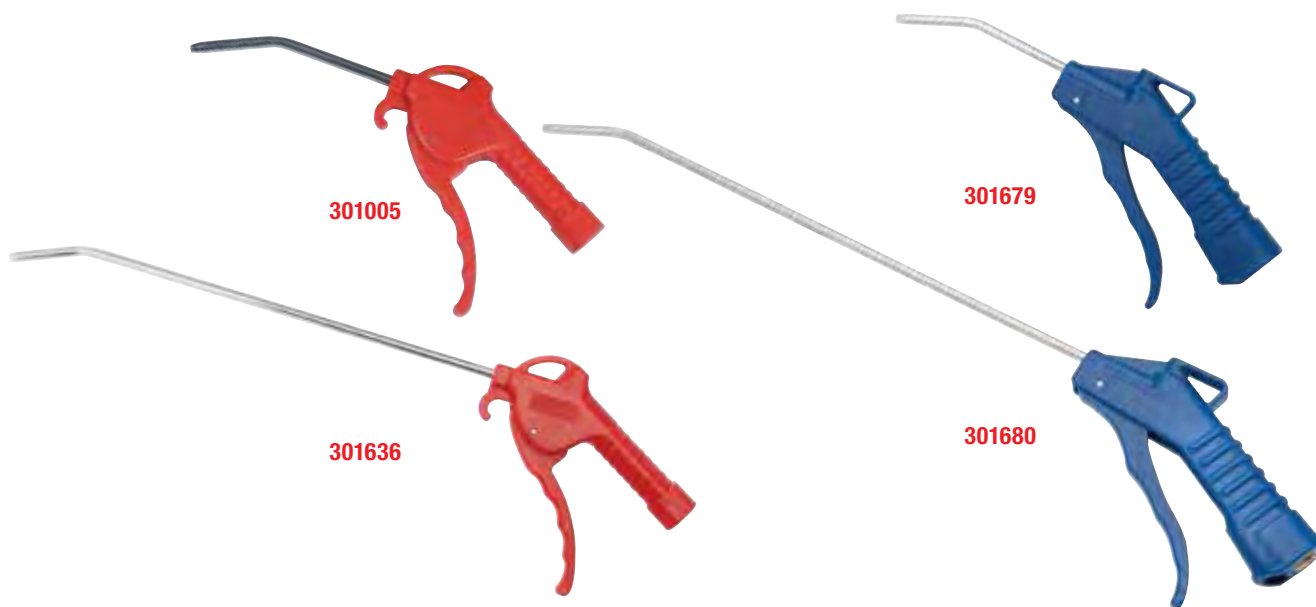

Part No.	Nozzle Length	Nozzle Width	Working Pressure	Inlet
301005	100mm	6mm	520-830 kPa (75-120 PSI/3.5-10 Bar)	1/4" NPT
301636	280mm	6mm	520-830 kPa (75-120 PSI/3.5-10 Bar)	1/4" NPT
301679	100mm	6mm	520-830 kPa (75-120 PSI/3.5-10 Bar)	1/4" NPT, Brass
301680	330mm	6mm	520-830 kPa (75-120 PSI/3.5-10 Bar)	1/4" NPT, Brass

Air Blow Gun Professional Rubber Tipped

- Features include rubber nose to eliminate scratching and marking and micro control valve for maximum air flow control
- Handy storage hanger hook
- Brass threaded air inlet ensures that threads do not shear with repeated use
- Manufactured from high impact plastic for premium quality and longevity



Part No.	Nozzle Length	Working Pressure
301681	100mm	520-830 kPa (75-120 PSI)



Air Blow Gun Straight Nozzle - Thumb Control

- Handy and reliable unit for air cleaning work areas, equipment etc.
- Heavy duty zinc alloy body with comfortable thumb lever control
- Adjustable nose for air flow control
- Ergonomic gun design for extended use without fatigue
- Small, compact and very user friendly
- ¼" NPT inlet



Part No.	Overall Length	Working Pressure
301682	115mm	520-830 kPa (75-120 PSI)

301640

In-Line Air Blow Tool

- Unique in-line blow gun designed for cleaning desired areas before and after jobs
- Flexible 350mm extension hose allows free movement of gun
- Attaches easily to standard air lines



Air Gun/Power Tool Holders

- Handy storage units for impact wrench and sockets in the workshop
- Holds one impact air wrench and four sockets
- Magnets on reverse side attach to metal holdings



301187



301448

Part No.	Description	Overall Length
301187	Nylon frame, two round magnets	370mm
301448	Heavy duty PVC dipped frame, four magnets, screw mountable	350mm

BANDING & CUTTING TOOLS

301104

Banding Tool with Cutter

- For fastening of band style clamps on CV boots
- Features crank and handle along with inbuilt cutting assembly to enable band style clamps to be tightened and cut in during installation
- Manufactured from steel construction with black powder coated finish for maximum durability
- Overall length: 230mm
- Maximum band width: 10mm (3/8")



CT1

Banding Tool with Cutter (Tridon Uniband)

- For tensioning and cutting of Tridon Uniband (UB series) style clamps and strapping
- Features crank handle along with inbuilt cutting assembly to enable band style clamps or strapping to be tensioned and cut in during installation
- Manufactured from heavy duty steel construction for maximum strength and durability
- Suitable for use on steel strapping up to 25mm (1")
- Overall length: 420mm (Max.)

Note: CT1 will not crimp the clamp or band, crimping is achieved by using Tridon Uniband Buckles available in 3 types (UBL, UBF and UBS part numbers)



CTC2065

Cable Tie Cutters Metal Cable Ties

- Provides automatic tensioning and cut-off of metal cable ties to produce a neat, clean and professional finish
- Ergonomically designed high impact plastic handles for maximum comfort and durability
- Cuts cable ties up to 12mm wide and 0.3mm thick
- Suits all Tridon stainless steel series cable ties



302500

Cable Tie Cutters Nylon Cable Ties

- Provides automatic tensioning and cut-off of nylon cable ties to produce a neat, clean and professional finish
- Adjustable tension knob used to alter cable tie tension to suit requirements
- Glass fibre reinforced polyamide construction - light and strong
- Simply wrap the cable tie around the item, feed the tail into the gun and squeeze the trigger
- Suits cable tie sizes: 2.4–4.8mm wide and 1.7mm thick





CLAMPING & VICES

Spring Clamps

- Flexible jaw spring clamps manufactured from high strength plastic
- Lightweight, holds object without force concentration
- Designed to grip flat or odd shaped surfaces
- Ergonomic handles for comfort and ease of operation

Part No.	Style	Jaw Opening (Max.)
301657	Single carded	25mm (1")
301659	Single carded	50mm (2")
301660	Single carded	75mm (3")
301656	Complete set (10 piece)	4 x 25mm (1") 4 x 50mm (2") 2 x 75mm (3")



G-Clamps

- Suitable for metalwork and woodwork applications
- Textured powder coated finish with black oxide finish on spindle screw to prevent corrosion
- Precision-cut screw for extra strength
- Broad swivel pad allows for even distribution of pressure on angled or uneven surfaces
- Suitable for industrial and construction applications where extra strength is required
- Made from high grade ductile 60,000 PSI S.G. iron castings

Part No.	Throat Capacity (C)	Throat Depth (D)
301876	75mm (3")	44mm
301871	100mm (4")	59mm
301872	150mm (6")	75mm
301873	200mm (8")	80mm
301874	250mm (10")	90mm
301875	300mm (12")	100mm

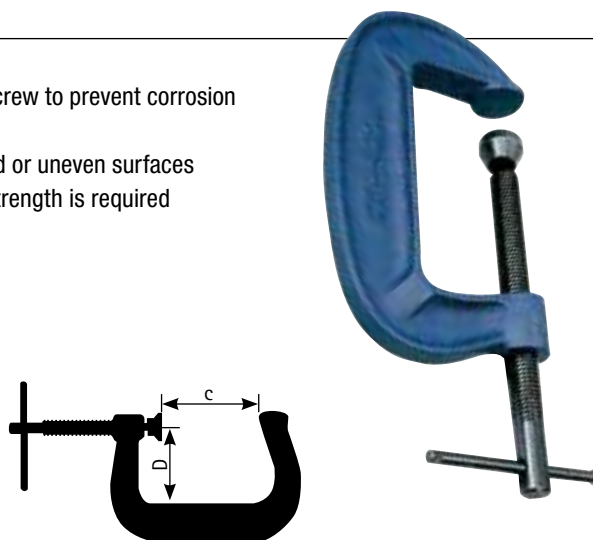

Welding G-Clamps

- Copper plated spindle ideal for welding
- The copper plated spindle screw prevents welding sparks sticking to the screw, making this clamp ideal for all welding applications
- Rust resistant grey enamel finish
- Precision-cut screw for extra strength
- Broad swivel pad allows for even distribution of pressure on angled or uneven surfaces
- Suitable for industrial, construction and automotive applications where extra strength is required
- Body made from drop forged steel

Part No.	Throat Capacity (C)	Throat Depth (D)
301877	100mm (4")	60mm
301878	150mm (6")	75mm

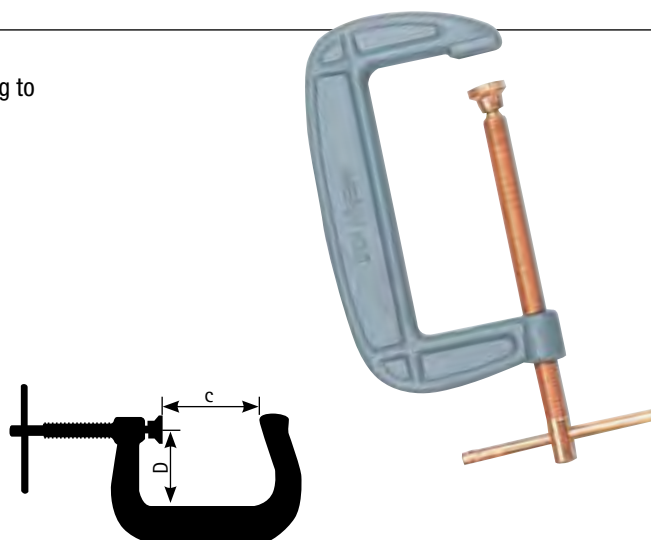



Bench Vices Cast Iron

- Manufactured from high quality grey iron castings with high compression strength along with excellent shock absorbing capabilities
- High quality precision machining delivers smooth operation and trouble free service life
- Fully enclosed spindle construction protects the threads from contaminants and damage
- Hardened jaws (45 +/- 5 HRC)
- Available in fixed and swivel styles
- 360° rotation swivel base is removable to allow vice to be converted to fixed base style if required
- Suitable for automotive, industrial, agricultural and mechanical engineering applications

Fixed Base - Straight

Part No.	Jaw Width	Jaw Opening	Weight	Spare Jaws (Pair)
301862	100mm	125mm	9.2kg	301865A
301863	150mm	175mm	21.4kg	301866A
301864	200mm	200mm	32.0kg	301867A



Swivel Base - Straight

Part No.	Jaw Width	Jaw Opening	Weight	Spare Jaws (Pair)
301865	100mm	125mm	12.0kg	301865A
301866	150mm	175mm	26.4kg	301866A
301867	200mm	200mm	44.0kg	301867A



Bench Vices Steel

- Manufactured with high quality steel construction to withstand shocks from hammering, chipping and other tough applications
- Integrated anvil for shaping and beating, along with an extra heavy duty sliding jaw and large diameter
- Forged tommy bar and main screw to assist with effective pressure transmission
- Carbon steel hardened jaws (50 +/- 5 HRC)

Fixed Base - Offset

Part No.	Jaw Width	Jaw Opening	Weight	Spare Jaws (Pair)
301868	100mm	120mm	7.5kg	301868A
301869	150mm	150mm	21.0kg	301869A
301870	200mm	200mm	43.0kg	301870A





CLEANING TOOLS

301909

Alloy Wheel Brush

- Non-scratching soft bristles specifically designed for cleaning alloy wheels
- Bends in order to access hard to reach, awkward and small crevices
- Overall length: 240mm



Cleaning Brushes

- Sturdy, compact and simple tools for small cleaning jobs, particularly those in hard to reach places and confined spaces
- Suitable for rust, scale, ingrained dirt removal
- Each set comes with one curved and one straight brush
- Overall length:
 - Curved: 220mm
 - Straight: 210mm
- 2 piece sets



Part No.	Description	Bristles
301001	2 piece set (1 x curved & 1 x straight)	Steel
301002	2 piece set (1 x curved & 1 x straight)	Nylon
301073	2 piece set (1 x curved & 1 x straight)	Brass
301074	2 piece set (1 x curved & 1 x straight)	Stainless steel

301003

Cleaning Brush Set

- Multi-purpose brush set comprising one brush each of nylon, brass and steel bristles
- Suitable for removing dirt, grime, rust scale, paint, alloy wheel cleaning
- Features ergonomic moulded plastic handle with finger positioning
- Overall length: 180mm
- 3 piece set





301004

Parts Brush

- Strong and durable brush with wooden handle and heavy duty flexible bristles
- Ideal for cleaning engine and transmission spares, brake parts and bearings
- Overall length: 260mm
- Bristle head diameter: 25mm



COMPONENT IDENTIFIERS

301059

Component Identifier

- Colour coded component identifier set used to assist in identifying components during reassembly
- Features a convenient retaining ring for easy and secure storage in tool box
- Supplied are 18 clips colour-coded in pairs which simply clip to the item during the dismantling process, ready to be identified for reassembly
- Manufactured from a tough, non-conductive plastic to ensure strength and longevity



301063

Vacuum Hose Marking Plug Set

- Convenient kit designed to assist in identifying vacuum hoses and fittings during reassembly
- Fit to hoses and fittings during disassembly to enable accurate and quick routing and reassembly
- Manufactured from tough non-conductive plastic for strength and durability
- Contains 49 colour coded pieces in 7 assorted colours
- Suitable for hoses 3-13mm

Sizes
3mm (1/8")
5mm (3/16")
6mm (1/4")
8mm (5/16")
9.5mm (3/8")
11mm (7/16")
12.5mm (1/2")





CYLINDER HONING TOOLS

301044

Engine Cylinder Hone 50-135mm

- This comprehensive specialist tool is designed for honing and deglazing engine cylinder bores
- Three legs featuring 100mm long, medium grit hone stones remove glaze in engine bores quickly and easily
- The centre spring uses variable spring tension to enable self centring and variation of contact intensity in the bore
- Operation is through a flexible shaft drive to ensure smooth honing
- Suitable for use under bonnet or on engine stand
- Replacement honing stones available
- Bore capacity (ID): 50–135mm
- Overall length: 365mm



Part No. (Spare)	Description	Qty	Length	Pic. Ref.
301050	Medium hone stone set	3	100mm	
301062	Coarse hone stone set	3	100mm	

Disc Brake Cylinder Hones

- Specialist 3 leg honing tools designed for deglazing cylinder bores on brake components
- Features three medium grit honing stones to remove glaze quickly and easily
- The centre spring uses variable spring tension to enable self centring and variation of contact intensity in the bore
- Suitable for brake wheel cylinders, master cylinders and calipers
- Operation is through a flexible shaft drive to ensure smooth honing
- Ideal for use at the vehicle or workbench
- Overall length: 210mm

Part No.	Description	Bore Capacity (ID)
301047	3 leg cylinder deglazing hone	32–89mm
301048	3 leg cylinder deglazing hone	19–50mm

Part No. (Spare)	Description	Qty	Length	Pic. Ref.
301055	Medium hone stone set	3	28mm	



301047



301048



301045

Brake & Small Engine Cylinder Hone 32-85mm

- Specialist 3 leg honing tool designed for deglazing cylinder bores on brake components and small engines
- Features three 50mm long, medium grit honing stones to remove glaze quickly and easily
- The centre spring uses variable spring tension to enable self centring and variation of contact intensity in the bore
- Operation is through a flexible shaft drive to ensure smooth honing
- Replacement honing stones available
- Bore capacity (ID): 32–85mm
- Overall length: 225mm

Part No. (Spare)	Description	Qty	Length	Pic. Ref.
301051	Medium hone stone set	3	50mm	



301046

Brake Cylinder Hone Triple Leg 19-64mm

- Specialist honing tool designed for deglazing cylinder bores on brake components
- Features three legs with 28mm long, medium grit honing stones to remove glaze quickly and easily
- The centre spring uses variable spring tension to enable self centring and variation of contact intensity in the bore
- Suitable for brake wheel cylinders, master cylinders and calipers
- Operation is through a flexible shaft drive to ensure smooth honing
- Bore capacity (ID): 19–64mm
- Overall length: 210mm

Part No. (Spare)	Description	Qty	Length	Pic. Ref.
301052	Fine hone stone set	3	28mm	
301053	Medium hone stone set	3	28mm	
301054	Coarse hone stone set	3	28mm	



301049

Brake Cylinder Hone Twin Leg 20-64mm

- Specialist honing tool designed for deglazing cylinder bores on brake components
- Features two legs with 28mm long, medium grit honing stones to remove glaze quickly and easily
- The centre spring uses variable spring tension to enable self centring and variation of contact intensity in the bore
- Suitable for brake wheel cylinders, master cylinders and calipers
- Operation is through a flexible shaft drive to ensure smooth honing
- Ideal for use at the vehicle or workbench
- Bore capacity (ID): 20–64mm
- Overall length: 210mm

Part No. (Spare)	Description	Qty	Length	Pic. Ref.
301056	Fine hone stone set	2	28mm	
301057	Medium hone stone set	2	28mm	
301058	Coarse hone stone set	2	28mm	





DIAGNOSTICS

Stethoscopes

- Speciality sonic diagnostic units used to locate noises within machinery, engines, compressors, transmissions, drive trains etc.
- Manufactured to Toledo's well renowned quality for superior durability and longevity
- Available in standard and enhanced electronic configurations

Stethoscope Standard

- Designed with an aluminium probe and extension for greater access to help pinpoint the location of the noise
- Features plastic earphones to reduce external noises during diagnosis
- Trumpet supplied only with Part No. 301010 and can be used to check vacuum and pressure leaks

Part No.	Description	Overall Length	Steel Extension	Trumpet
301009	Stethoscope with extension	740mm	220mm	-
301010	Stethoscope with rubber trumpet	875mm	275mm	110mm

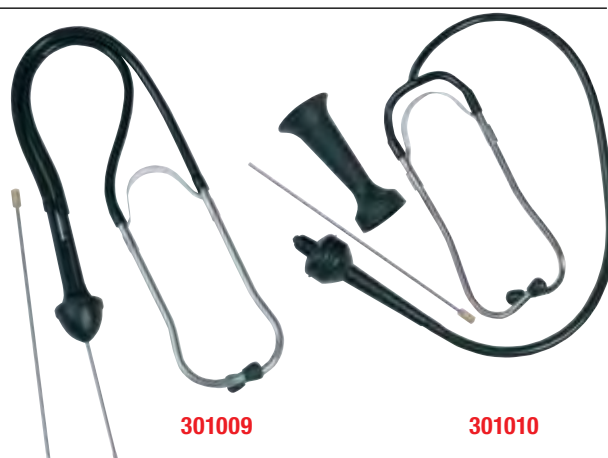

301637

Stethoscope Electronic

- Professional diagnostic tool supplied with headset, adjustable microphone with volume control and flexible probe to better detect and isolate noises
- Features a 9V battery (included)
- Probe length: 200mm

Part No. (Spare)	Description
301638	Headphones
301639	Probe assembly



301077

Inspection Camera

- Easy and reliable diagnostic tool used to locate and investigate a myriad of issues
- Flexible probe used to access confined non-visible areas
- Six powerful LED lights to illuminate imagery
- Waterproof cord and lens
- Powered by two AA batteries which will provide an average of two hours use
- Supplied in custom moulded storage case

Lens	Probe	Screen	Resolution
9mm	1m	82mm colour LCD	16 mega pixel
Part No. (Spare)	Description		
301077A	Replacement lens & flexible cord		





321500

Infrared Thermometer

- Portable and easy to use tool designed specifically for point and shoot temperature taking
- Features laser sighting for simple one hand operation, backlit LCD display, auto-hold function and auto power off
- Ideal for automotive, plumbing or industrial use



Specifications

Display	LCD
Auto Power Off	10 seconds
Battery	9v (NEDA 1604, IEC 6F22006p)
Battery Life	9 hours (continuous use)
Dimensions	148H x 105W x 42D (mm)
Weight	157g
Laser	<1mW, Class 2 laser
Range	-30°C to 550°C
Accuracy	±2°C on -30°C to 100°C, ±2% on -101°C to 550°C

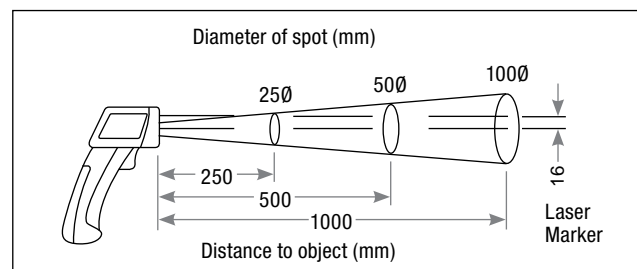

Spot size increases with distance from the probe tip as shown

Inspection Mirrors

- All Toledo inspection mirrors offer the same versatility by incorporating a universally adjustable swivel head allowing vision and access of otherwise hindered areas
- The Toledo range offers a wide selection of various sizes and configurations to ensure maximum choice and best fit for application

301011

Oval Telescopic Pocket Mirror

- Features pocket clip

Mirror Dimension	Telescopic Range	Handle
25 x 50mm	200–520mm	Steel



301012

Square Telescopic Mirror

- PVC dipped handle

Mirror Dimension	Telescopic Range	Handle
50 x 88mm	215–490mm	PVC dipped





301016

Circular Telescopic Mirror

- PVC dipped handle

Mirror Dimension (Ø)	Telescopic Range	Handle
50mm	200–355mm	PVC dipped

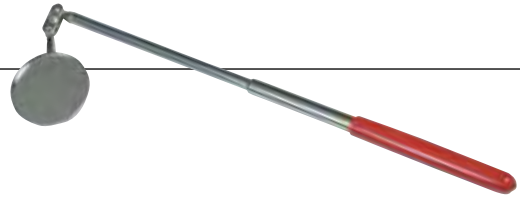

301013

Oval Inspection Mirror with Light

- Flexible shaft allows greater access to restricted areas
- Double ball joint swivel for maximum coverage
- Replaceable bulb to illuminate viewing and inspection
- Supplied with easy cord hanger attachment
- Replacement globe available Part No. 301330

Mirror Dimension	Overall Length	Batteries (not included)
25 x 50mm	440mm	2 x AA



Inspection Mirrors with LED Light (Premium)

- Replaceable LED bulb for maximum service life
- Ball joint swivel is adjustable for variable tension and stiffness
- Handy pocket clip

Part No.	Telescopic Range	Mirror Dimension	Batteries (included)
321012	100–530mm	Circle (Ø): 60mm	3 x button cell
321013	100–530mm	Oval: 80 x 50mm	3 x button cell

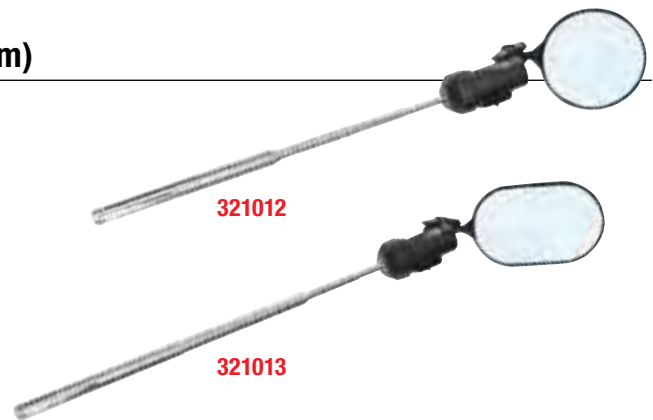

301015

Light, Mirror & Pick-Up Tool Set

- Simple and handy inspection and pick-up tool
- Strong flexible probe can be manipulated and hold shape to provide maximum usability
- Stainless steel probe with inbuilt light and magnet with an optional oval mirror attachment
- Replacement globe available Part No. 301331

Mirror Dimension	Length	Batteries (not included)
25 x 50mm	440mm	2 x AA

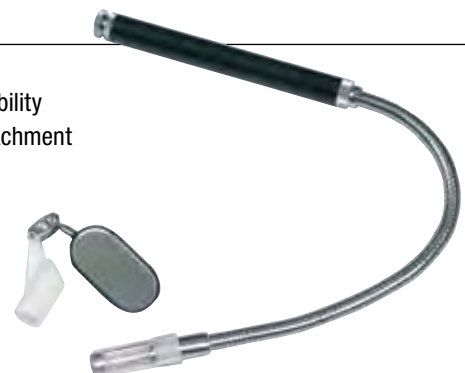



WORKSHOP TOOLS

301336

Combination Inspection & Pick-Up Kit

- Includes one unit with four interchangeable heads including three different pick-up tools (capacities 0.5, 2.2 and 3.6 Kgs) and one circle inspection mirror
- Pick-up tool heads include two standard and one ball joint styles
- Kit also includes one complete rectangle mirror inspection tool
- Supplied in custom moulded reusable foam storage tray

Telescopic Range	Rectangular Mirror	Circular Mirror (Ø)
160 x 680mm	53 x 82mm	32mm

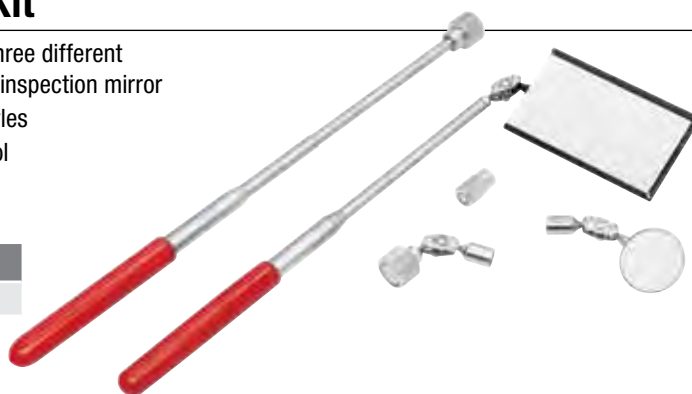

Inspection Lights

- Simple and handy units used for inspection of dark and restricted areas
- Provide illumination and allow for greater access to confined areas

Inspection Lights Flexible Cord

- Flexible stainless steel probe bends and holds in all positions
- Narrow and long probe gives access to confined spaces



Part No.	Description	Handle	Magnet Capacity	Shaft (Ø)	Shaft Length	Overall Length	Batteries (not included)	Spare Globe Part No.
301018	Flexible shaft with light	Plastic	750g	9mm	290mm	430mm	2 x AA	301332
301335	Flexible shaft with light	Plastic	300g	11mm	540mm	720mm	3 x AA	301333

301399

Inspection Light Kit Flexible Cord, LED Professional

- Innovative replaceable LED bulbs
- 3 bulbs including UV, White and Blue (1 of each)
- Magnetic head with 500g pick-up capacity
- Magnetic base with 1.5kg pick-up capacity
- 38mm diameter detachable mirror
- Replacement globe available Part No. 301399A

Magnetic Capacity		Mirror Dimension (Ø)	Batteries (included)
Head	Base		
50g	1500g	Circle: 38mm	3 x button cell





FEELER GAUGES

Feeler Gauge Sets

- Manufactured from high quality stainless steel for strength, durability and accuracy*
 - Designed for measurement of small gaps, ideal for use in engineering and automotive applications
 - Available in metric and SAE with various set combinations including straight, tapered and cranked blade design
- * Some sets include brass blades for automotive electronic ignition applications

301155

Feeler Gauge Straight 38 Blade Metric/SAE

- 35 stainless steel blades and 3 brass blades (electronic ignition timing)
- Straight blade design
- Metric and SAE sizing
- Size range: 0.038mm (0.0015") – 0.889mm (0.035")



Blade Size: Metric (SAE)				
0.038 (0.0015)	0.203 (0.008)	0.356 (0.014)	0.559 (0.022)	0.762 (0.030)
0.051 (0.002)	0.229 (0.009)	0.381 (0.015)	0.584 (0.023)	0.787 (0.031)
0.076 (0.003)	0.254 (0.010) *B	0.406 (0.016)	0.610 (0.024)	0.813 (0.032)
0.102 (0.004)	0.254 (0.010)	0.432 (0.017)	0.635 (0.025)	0.838 (0.033)
0.127 (0.005)	0.279 (0.011)	0.457 (0.018)	0.660 (0.026)	0.864 (0.034)
0.152 (0.006)	0.305 (0.012) *B	0.483 (0.019)	0.686 (0.027)	0.889 (0.035)
0.178 (0.007)	0.305 (0.012)	0.508 (0.020)	0.711 (0.028)	
0.203 (0.008) *B	0.330 (0.013)	0.533 (0.021)	0.737 (0.029)	*B = Brass

301156

Feeler Gauge Dual Straight 22 Blade Metric/SAE

- 22 stainless steel blades
- Dual measurement straight blade design with 2 sizes per blade
- Metric and SAE sizing
- Size range: 0.102mm (0.004") – 0.686mm (0.027")

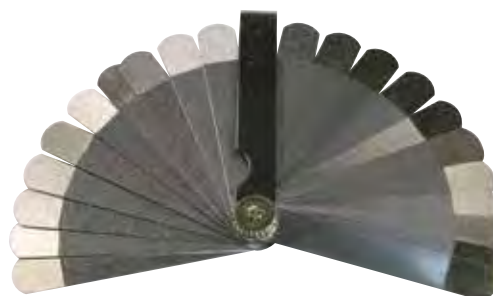

Blade Size: Metric (SAE)	
0.102 (0.004) / 0.152 (0.006)	0.254 (0.010) / 0.305 (0.012)
0.127 (0.005) / 0.178 (0.007)	0.279 (0.011) / 0.330 (0.013)
0.152 (0.006) / 0.203 (0.008)	0.305 (0.012) / 0.356 (0.014)
0.178 (0.007) / 0.229 (0.009)	0.330 (0.013) / 0.381 (0.015)
0.203 (0.008) / 0.254 (0.010)	0.356 (0.014) / 0.406 (0.016)
0.229 (0.009) / 0.279 (0.011)	0.381 (0.015) / 0.432 (0.017)

Blade Size: Metric (SAE)	
0.406 (0.016) / 0.457 (0.018)	0.533 (0.021) / 0.584 (0.023)
0.432 (0.017) / 0.483 (0.019)	0.559 (0.022) / 0.610 (0.024)
0.457 (0.018) / 0.508 (0.020)	0.584 (0.023) / 0.635 (0.025)
0.483 (0.019) / 0.533 (0.021)	0.610 (0.024) / 0.660 (0.026)
0.508 (0.020) / 0.559 (0.022)	0.635 (0.025) / 0.686 (0.027)



301157

Feeler Gauge Cranked 26 Blade Metric/SAE

- 26 cranked (45°) stainless steel blades
- Cranked blade design, ideal for access in restricted applications
- Metric and SAE sizing on each blade
- Size range: 0.127mm (0.005")–0.762mm (0.030")

Blade Size: Metric (SAE)			
0.127 (0.005)	0.305 (0.012)	0.483 (0.019)	0.660 (0.026)
0.152 (0.006)	0.330 (0.013)	0.508 (0.020)	0.686 (0.027)
0.178 (0.007)	0.356 (0.014)	0.533 (0.021)	0.711 (0.028)
0.203 (0.008)	0.381 (0.015)	0.559 (0.022)	0.737 (0.029)
0.229 (0.009)	0.406 (0.016)	0.584 (0.023)	0.762 (0.030)
0.254 (0.010)	0.432 (0.017)	0.610 (0.024)	
0.279 (0.011)	0.457 (0.018)	0.635 (0.025)	

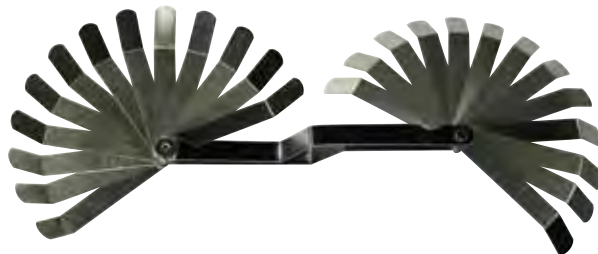

301158

Feeler Gauge Tapered 10 Blade SAE

- 10 stainless steel blades
- Tapered blade design
- SAE sizing
- Size range: 0.0015"–0.025"

Blade Size: SAE				
0.0015	0.003	0.006	0.01	0.015
0.002	0.004	0.008	0.012	0.025



301159

Feeler Gauge Tapered 10 Blade Metric

- 10 stainless steel blades
- Tapered blade design
- Metric sizing
- Size range: 0.04–0.63mm

Blade Size: Metric				
0.04	0.08	0.15	0.30	0.50
0.06	0.10	0.20	0.40	0.63



301160

Feeler Gauge Tapered 16 Blade Metric/SAE

- 16 stainless steel blades
- Tapered blade design
- Metric and SAE sizing
- Size range: 0.05–0.38mm and 0.002"–0.015"

Blade Size: Metric		Blade Size: SAE	
0.05	0.20	0.002	0.008
0.08	0.25	0.003	0.010
0.10	0.30	0.004	0.012
0.15	0.38	0.006	0.015





HOSE TOOLS

301151

Hose Remover

- Designed specifically for manipulating the seal when removing or working with hoses
- Two clever hook designs reach into the hard to get areas where working space is limited
- Features ergonomic moulded plastic handle for superior grip and manoeuvrability
- Overall length: 200mm
- 2 piece set

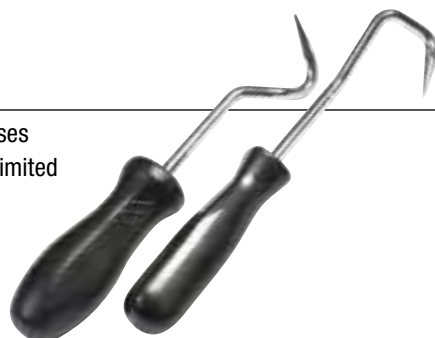

321002

Punch Tool Preform Band Clamp

- Safely and quickly installs preform style clamp
- Tool has tension, punch and cut off function
- Supplied with complete operating instructions

Application	Overall Length	Replacement Punch Part No.
15 and 16mm wide preform band clamps	300mm	321002A



Hose Clamp Nut Drivers

- Designed for the trouble free installation and removal of most modern hose clamps
- Featuring a flexible shaft to allow access to hard to reach hose clamps and an ergonomic handle for comfort and superior grip
- Includes socket attachments: 6mm, 7mm, and 8mm
- Suitable for use on all Tridon worm drive hose clamps

Part No.	Overall Length
CND-1	150mm
CND-2	300mm
CND-3	600mm
CND-4	900mm

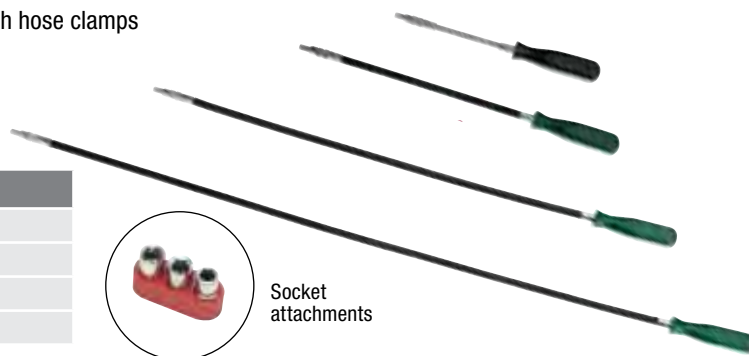

Torque Screwdrivers

- Torque metered screwdriver ideal for screws, bolts and hose clamps where a specific torque is required
- Ergonomic handle includes inbuilt torque meter viewing window to set, lock or adjust the torque unit
- Includes socket attachments: 6mm, 7mm and 8mm
- Suitable for use on all Tridon worm drive hose clamps
- Supplied in protective blow mould case

Part No.	Description
CTD-1	Short driver head, 1/4" Sq. Dr. 0.5Nm increments
CTD-2	Long driver head, 1/4" Sq. Dr. 0.5Nm increments



KEYS AND BITS

301987

T-Handle Set Hex Key

- T-Handle design with hex key fittings on each point of the tool (3 in total) for quick and easy operation
- For the removal and installation of hex style screws, bolts and fittings
- Manufactured from heat treated chrome vanadium steel
- 8 piece set supplied in protective wallet

Hex



Contents

Part Number	Size	Length
301728	2.0mm	125mm
301729	2.5mm	125mm
301730	3.0mm	125mm
301731	3.5mm	125mm
301732	4.0mm	180mm
301733	4.5mm	180mm
301734	5.0mm	180mm
301735	6.0mm	210mm

301988

T-Handle Set Torx

- T-Handle design with torx fittings on each point of the tool (3 in total) for quick and easy operation
- For the removal and installation of torx screws, bolts and fittings
- Manufactured from heat treated chrome vanadium steel
- 7 piece set supplied in protective wallet

Torx (6-Point star)



Contents

Part Number	Size	Length
301742	T10	125mm
301743	T15	125mm
301744	T20	125mm
301745	T25	180mm
301746	T27	180mm
301747	T30	180mm
301748	T40	210mm

301119

Tamper Proof Torx Tool

- Compact tool design with tamper proof (six point) fittings on each end for quick and easy operation
- For the removal and installation of six point screws, bolts and fittings
- Manufactured from heat treated chrome vanadium steel
- Contains 8 tamper proof sizes
- Sizes T9, T10, T15, T20, T25, T27, T30, T40

Tamper Proof Torx (6-Point star)

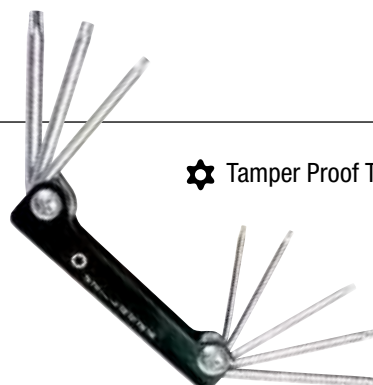



Hex Key Set Ball Point

- Features “standard hex” and “ball hex” design
- Ball end allows improved access to application and up to 25° working angle for increased speed and ease of entry
- Manufactured from heat treated vanadium steel with industrial black finish
- 7 piece sets supplied in a storage case available in Metric and SAE sizes

Part No.	Description	Part No.	Description
HKM	Metric (7 piece)	HKAF	SAE (7 piece)
Size	Length	Size	Length
2.5mm	90mm	3/32"	90mm
3.0mm	100mm	1/8"	100mm
4.0mm	110mm	5/32"	110mm
5.0mm	115mm	3/16"	115mm
6.0mm	140mm	1/4"	140mm
8.0mm	160mm	5/16"	160mm
10.0mm	180mm	3/8"	180mm

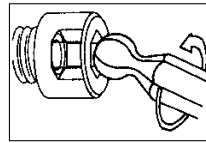

Hex

301667

Bit Set Torx

- Compact bit set with nine torx bits, 1/4" and 3/8" square drive bit holder
- For the removal and installation of torx screws, bolts and fittings
- Manufactured from heat treated vanadium steel
- 11 piece set supplied in moulded storage magazine

Torx (6-Point star)

Contents

Description	Size
Bit Holder	1/4" Sq. Dr. x 1/4" hex
Bit Holder	3/8" Sq. Dr. x 5/16" hex
1/4" Bits	T10, T15, T20, T25, T27, T30
3/8" Bits	T40, T45, T50



301668

Bit Set Tamper Proof Torx

- Compact bit set with seven tamper proof torx bits and 1/4" square drive bit holder
- For the removal and installation of torx screws, bolts and fittings
- Manufactured from heat treated vanadium steel
- 8 piece set supplied in moulded storage magazine

Tamper Proof Torx (6-Point star)

Contents

Description	Size
Bit Holder	1/4" Sq. Dr. x 1/4" hex
1/4" Bits	T10, T15, T20, T25, T27, T30, T40



301318

Bit Set Tamper Proof Five Point

- Compact bit set with a variety of five point tamper proof combinations
- For the removal and installation of five point screws, bolts and fittings
- Features five point bit sizes T10, T15, T20, T25, T27, T30, T40, T45, T50
- Includes 1/4" square drive x 1/4" hex socket adaptor, 1/4" hex drive and 60mm long bit adaptor
- Manufactured from heat treated vanadium steel
- 11 piece set supplied in a durable storage case



Tamper Proof
5 Point



301168

Bit Set Ribe

- Compact bit set with a variety of 6-lobe ribe or polydrive head combinations commonly used in European vehicle applications
- Manufactured from heat treated vanadium steel
- 21 piece set supplied in a durable storage case

Ribe Bits

Contents

Bit Type	Size Range	Qty
10 x 40mm L Ribe Bits	M5, M6, M7, M9, M10 (S2)	1
	M10, M11, M12, M13 (CR-V)	1
10 x 75mm L Ribe Bits	M5, M6, M7, M8, M9, M10 (S2)	5
	M11, M12, M13, M14 (CR-V)	4
CR-V Bit holder	3/8" Sq. Dr.	6
	1/2" Sq. Dr.	4



301096

Bit Set

- Compact bit set with a variety of popular screw head combinations including Slotted, Phillips, Pozidriv, Tamper Proof Torx and Hex
- 1/4" square drive bit holder also included
- For the removal and installation of screws, bolts and fittings ideal for use with power screwdrivers or drills
- Manufactured from heat treated vanadium steel
- 33 piece set supplied in a storage magazine

Contents

Bit Type	Size	Qty
Phillips	PH0, PH1, PH2, PH3	4
Pozidriv	PZ0, PZ1, PZ2(x4), PZ3	7
Slotted	SL3, SL3.5, SL4, SL4.5, SL5.5, SL6.5	6
Hex	H1.5, H2, H2.5, H3, H4, H5, H5.5, H6	8
Temper Proof Torx	T10, T15, T20, T25, T27, T30	6
Bit Holder	1/4" Sq. Dr.	1



301934

Bit Set Professional

- Compact professional combination bit set includes a variety of Ribe, Hex, Torx and Spline bits with 90mm extension and 3/8" and 1/2" square drive adaptors
- Manufactured from hardened and tempered alloy steel
- 37 piece set supplied in a professional metal storage case

Contents

Bit Type	Size/Description	Qty
Ribe bits	M4, M5, M6, M7, M8, M9, M10, M12, M13, M14	10
Hex bits	4, 5, 6, 8, 10, 12 (mm)	6
Spline bits	M4, M5, M6, M8, M10, M12	6
Torx bits	T10, T15, T20, T25, T27, T30, T40, T45, T50, T55, T60, T70	12
Hex bit holder	1/2" Sq. Dr. x 10mm	1
Hex bit holder	3/8" Sq. Dr. x 10mm	1
90mm Extension	10mm bit holder	1













301447

Bit Set Master

- Compact bit set with a variety of popular screw head combinations including Slotted, Phillips, Pozidriv, Torx, Tamper Proof Torx and Hex
- 1/4" square drive bit holder also included
- For the removal and installation of screws, bolts and fittings, ideal for use with power screwdrivers or drills
- Manufactured from heat treated vanadium steel
- 100 piece set supplied in a durable storage case

Contents

Bit Type		Size	Qty (per size)
Phillips		PH1, PH2, PH3	7
Pozidriv		PZ1, PZ2, PZ3	7
Slotted		SL4, SL6	7
Hex		H4, H5, H6	7
Torx		T10, T15, T20, T25, T27, T30, T40	2
Tamper proof Torx		T10, T15, T20, T25, T27, T30, T40	1
Quick release bit holder		1/4" Sq. Dr.	1
Bit holder		1/4" Sq. Dr.	1



PICK-UP TOOLS

Magnetic Pick-Up Tools

- Handy tools suitable for picking up small magnetic pieces in hard to reach and confined spaces
- Common uses include pick-up of small ferrous items such as nuts, bolts, washers etc

301015

Light, Mirror & Pick-Up Tool Set

- Simple and handy inspection and pick-up tool
- Strong flexible probe can be manipulated and hold shape to provide maximum usability
- Stainless steel probe with inbuilt light and magnet with an optional oval mirror attachment
- Replacement globe available Part No. 301331

Mirror Dimension	Overall Length	Batteries
25 x 50mm	440mm	2 x AA

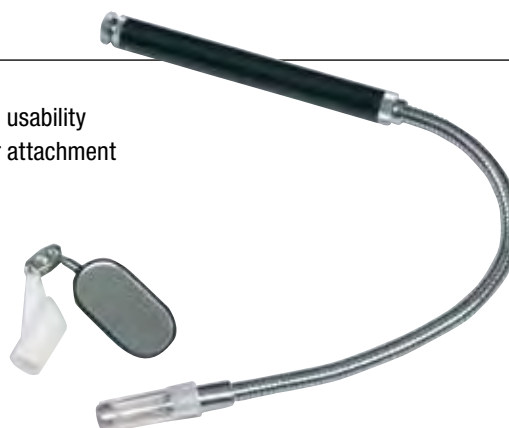



Pocket Magnets Telescopic

- Telescopic body for adjustable reach
- Features strong magnetic power for firm retrieval and pick-up of ferrous material
- Manufactured from durable stainless steel with pocket clip



Part No.	Description	Handle	Telescopic Range	Magnet (Ø)	Magnet Capacity
301014	Pocket size with inbuilt scriber & pocket clip	Steel	150–670mm	6mm	200g
301019	Pocket size with pocket clip	PVC dipped	125–640mm	13mm	2500g
301020	Includes secondary magnet in handle for easy storage	Plastic	170–540mm	6mm	800g
301021	Swivel dual ball joint head	Ergonomic rubber	310–700mm	10.5mm	1600g
301298	Pocket size with pocket clip	Rubber moulded	170–760mm	7mm	700g
301299	Pocket size with pocket clip	Rubber moulded	170–760mm	13mm	3600g

Magnets Flexible Cord

- Narrow and long probe gives access to confined spaces
- Flexible stainless steel probe bends and holds in all positions

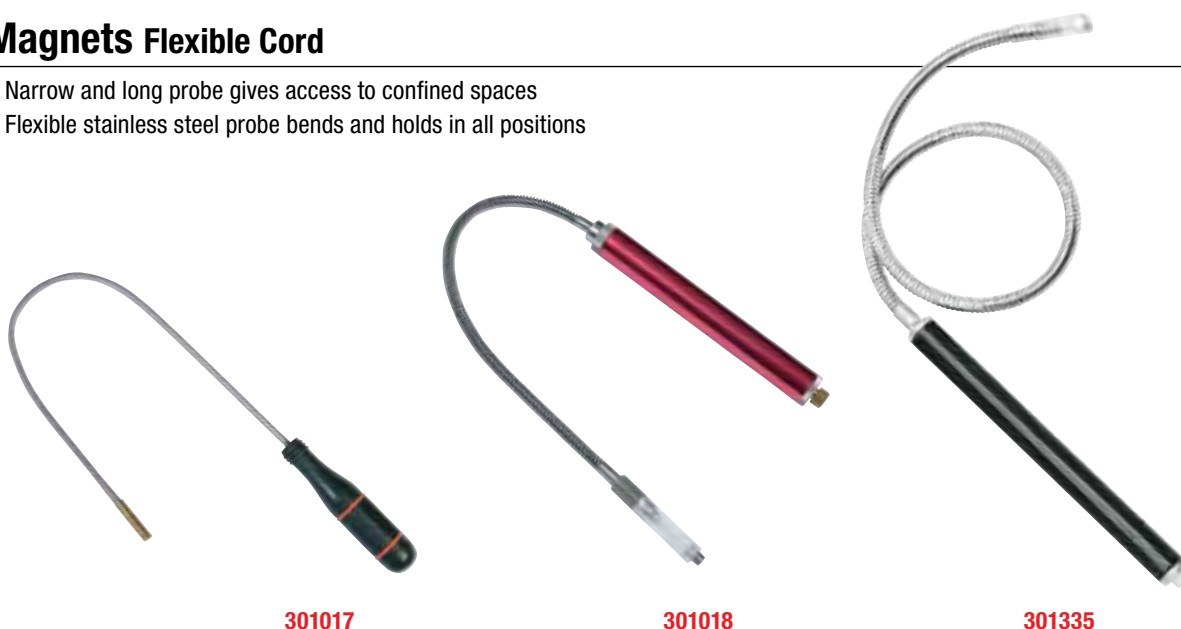

Part No.	Description	Handle	Magnet Capacity	Shaft (Ø)	Shaft Length	Overall Length	Batteries (not included)	Part No. (Spare Globe)
301017	Flexible shaft	Plastic, Knurled	500g	6.5mm	405mm	510mm	N/A	–
301018	Flexible shaft with light	Plastic	750g	9mm	290mm	430mm	2 x AA	301332
301335	Flexible shaft with light	Plastic	300g	11mm	540mm	720mm	3 x AA	301333



301336

Combination Inspection & Pick-Up Kit

- Includes one unit with four interchangeable heads including three different pick-up tools (capacities 0.5, 2.2 and 3.6 Kgs) and one circle inspection mirror
- Pick-up tool heads include two standard and one ball joint styles
- Kit also includes one complete rectangle mirror inspection tool
- Supplied in custom moulded reusable foam storage tray

Telescopic Range	Rectangular Mirror	Circular Mirror (Ø)
160 x 680mm	53 x 82mm	32mm



301399

Inspection Light Kit Flexible Cord, LED Professional

- Innovative replaceable LED bulbs
- 3 bulbs including UV, White and Blue (1 of each)
- Magnetic head with 500g pick-up capacity
- Magnetic base with 1.5kg pick-up capacity
- 38mm diameter detachable mirror
- Replacement globe available Part No. 301399A

Magnetic Capacity		Mirror Dimension (Ø)	Batteries (included)
Head	Base		
500g	1.5kg	Circle: 38mm	3 x button cell



Retrieval Tools Flexible Shaft Claw

- Featuring flexible shaft with spring loaded extendable retrieval claw function
- Pressing the button downward extends the spring loaded claw, as the button returns to rest position the claw closes and secures object
- Two styles available

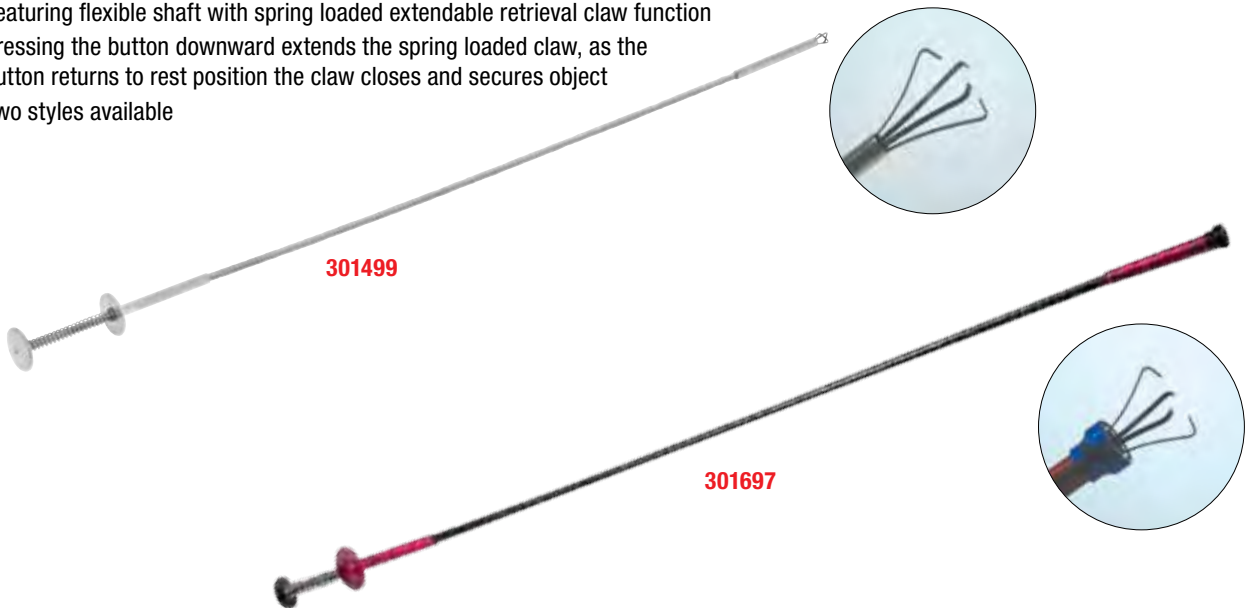

Part No.	Probe (Ø)	Head (Ø)	Claw Opening (Max.)	Overall Length
301499	6mm	7mm	25mm	600mm
301697	7mm	15mm	25mm	700mm



WORKSHOP TOOLS

Retrieval Tools Broom Style Telescopic

- Designed as a heavy duty option for retrieving ferrous material from workshop floors and surrounding areas
- Broom style with telescopic handle is simple, efficient and easy to use
- Featuring strong magnet capacity of either 5kg or 9kg
- Features quick release function and in-built wheels to provide an easy way of manoeuvring the unit around the workshop or factory floor (301189 only)

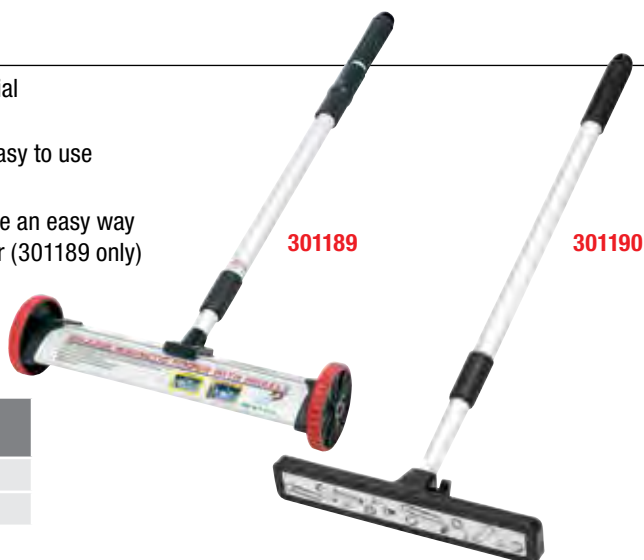

Part No.	Telescopic Range	Head Width	Magnet Capacity	Overall Length
301189	650–960mm	385mm	9000g	700mm
301190	670–1100mm	310mm	5000g	600mm

PIPE TOOLS

- Toledo's extensive range of pipe tools are manufactured from durable materials to ensure the quality and prolonged service life expected from Toledo tools
- Designed for bending, manipulating, gripping and cutting various sized tubing and pipes made from copper, brass, aluminium and mild steel

301701

Flaring Tool Double Lap

- Extensive pipe and tubing manipulation kit for copper, brass, mild steel and aluminium type tubing
- The die block and flaring adaptors are suitable for creating single and double lap flares in sizes 4.75, 5, 6, 8, and 10mm
- Kit includes a mini tube cutter capable of cutting plastic, brass, copper, aluminium and mild steel tubing between 3-15mm (1/8"–9/16") O.D.



Flaring

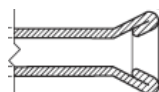

Double Lap Flaring



Contents

Part No.	Description
301702	Flaring adaptor 4.75mm
301703	Flaring adaptor 5mm
301704	Flaring adaptor 6mm
301705	Flaring adaptor 8mm
301706	Flaring adaptor 10mm
301032	Mini tube cutter



301300

Flaring & Swaging Kit

- This comprehensive kit includes a drop forged vanadium steel yoke and die blocks designed for carrying out cold swaging and flaring
- The range of adaptors and two die blocks accommodate 3mm to 20mm tubing
- Applicable for use on copper, brass and aluminium tubing
- Suitable for automotive, plumbing, industrial and hardware applications

Tubing (Ø)		Flares	Swages
Metric	SAE		
3mm	1/8"	•	–
5mm	3/16"	•	•
6mm	1/4"	•	•
8mm	5/16"	•	•
10mm	3/8"	•	•
16mm	5/8"	•	•
20mm	25/32"	•	•



301879

Brake & Fuel Line Flaring Kit

- Designed for pipe and tube flaring and double lap flaring sizes 4.75mm (3/16") or 6mm (1/4")
- Suitable for thin wall steel, aluminium or copper
- Can be hand held for use directly at the application if required
- Enables corroded or damaged piping to be replaced or renewed
- The punch and clamp adaptors can be changed quickly and easily for the different flare sizes

Contents

Part No.	Description
301880	Flare kit spacer
301881	Flare kit punch 3/16"
301882	Flare kit punch 1/4"
301883	Flare kit handle
301884	Flare kit handle sleeve
301885	Flare kit lead screw
301886	Flare kit e-ring
301887	Flare kit washer
301888	Flare kit clamp 3/16"
301889	Flare kit clamp 1/4"

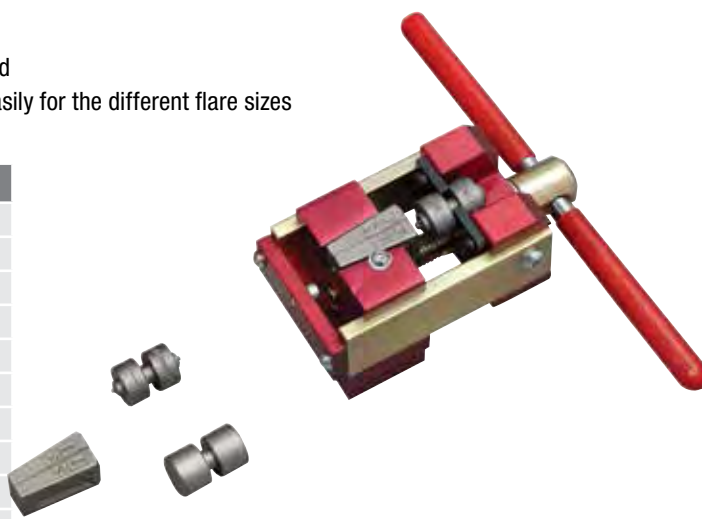

Tube Benders

- Toledo tube benders feature a durable metal construction for superior toughness and longevity
- Simple yet effective operation with built in gauge to ensure accurate bending from 0-180° of movement
- Bends copper, brass, aluminium and mild steel tubing
- Knurled handles for maximum grip and comfort

Part No.	Tube Capacity	Overall Length
301034	6, 8, 10mm	260mm
301036	4, 6, 8, 10mm	320mm



301034



301036



WORKSHOP TOOLS

301698

Tube Bender, Plier Type Heavy Duty

- Bends copper and steel without kinking or flattening
- Roller adaptors are locked into place with locating pin
- Place tube between adaptor and stud then squeeze handle to make the necessary bend
- Replacement rollers available

Tube Capacity	Overall Length
3/16", 1/4", 5/16", 3/8"	260mm

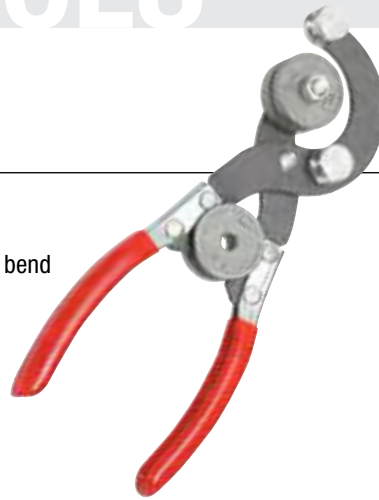

321005

Tube Flaring, Bending & Cutting Kit

- Comprehensive pipe manipulation kit contains 3 tools in 1, including mini tube cutter, hand held tube bender and flaring tool
- Suitable for copper, brass, aluminium and mild steel tubing
- Flaring tool sizes: 3/16", 1/4", 5/16" and 3/8"
- Tube bender sizes: 3/16", 1/4", 5/16" and 3/8"
- Mini tube cutter suits pipe sizes: 1/8"–9/16"



Pipe Wrenches

- Feature serrated adjustable locking jaw design to enable quick and secure operation once force is applied
- Ideal for use on pipes or bolts where additional strength is required
- Available in a range of sizes between 250mm (10") and 900mm (36") in length
- Manufactured from carbon steel with drop forged jaws for strength and durability

Part No.	Length	Pipe Size (Max.)
301217	250mm (10")	38mm (1½")
301218	300mm (12")	38mm (1½")
301219	350mm (14")	51mm (2")
301220	450mm (18")	63mm (2½")
301221	600mm (24")	76mm (3")
301222	900mm (36")	127mm (5")



PRY BARS

301070

Pry Bar Jumbo

- Features square shanked shaft with flat blade end and plastic grip handle with impact head
- Suitable for automotive, industrial and hardware applications
- Manufactured from high quality alloy steel for strength and durability
- Overall length: 780mm

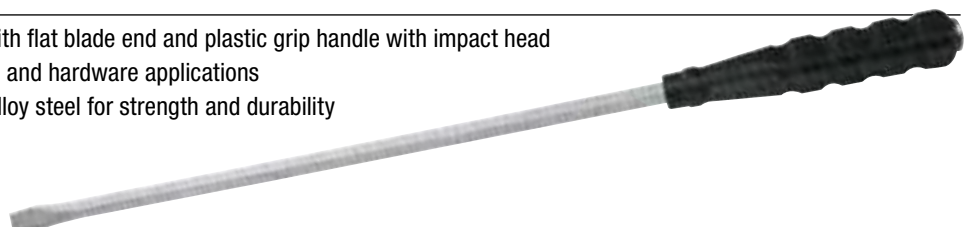



301186

Pry Bar Adjustable

- Features heavy duty pry bar and podger design with adjustable locking pry bar shaft allowing adjustment from 540mm to 810mm
- Tapered podger end ideal for alignment of bolt holes
- Suitable for automotive, industrial and hardware applications
- Manufactured from solid steel construction
- Length: 540–810mm



301083

Pry Bar Set Standard

- Features square shanked bars with angled heads and plastic grip handles
- Suitable for automotive, industrial and hardware applications
- Manufactured from high quality alloy steel with industrial black finish for strength and durability
- 4 piece set contains 200, 300, 450, 600 (mm) bars



301673

Pry Bar Set Rolled Head

- Features hardened and machined rolled-head (hook) and pointed (podger) end design
- Rolled head enables high leverage operation and tapered podger end ideal for alignment of bolt holes
- Suitable for automotive, industrial and hardware applications
- Manufactured from chrome vanadium steel for strength and durability
- 4 piece set



Contents

Part No.	Overall Length
301674	150mm
301675	300mm
301676	400mm
301677	500mm

301684

Pry Bar Set Combination

- Features a selection of wedge, angled and straight levers in varying lengths for versatility in hard to reach areas or where work space is limited
- Ideal automotive panel and dent repair applications
- Manufactured from quality tempered alloy steel for strength and rigidity

Contents

Part No.	Type	Overall Length
301685	Straight bars	290mm
301686		470mm
301687		580mm
301688		740mm
301689		890mm
301690	45° bar	490mm
301691	90° bar	420mm
301692	Flat blade wedge	130mm
301693	Wide one sided wedge	140mm





SCRAPING & MARKING

301008

Scraper & Hook Set

- Suitable for automotive, industrial and hardware applications
- Ideal for scraping, scribing, marking, picking and seal removal
- Manufactured from heat treated alloy steel with comfort grip handles
- 5 piece set

Contents

Style	Overall Length	Tip
Cotter pin puller	225mm	Angled point - 90°
Scratch awl	200mm	Straight point
Hose remover	175mm	Curved point - 90°
Scraper	210mm	Flat blade - 20mm
Scraper	285mm	Flat blade - 25mm



301043

Pick & Hook Set Miniature

- Suitable for automotive, industrial and hardware applications
- Ideal for scraping, scribing, marking, picking and seal removal
- Manufactured from heat treated alloy steel with comfort grip handle
- 4 piece set

Contents

Style	Overall Length	Tip
Scratch awl	130mm	Straight point
Hook	130mm	Hook
Pick	130mm	Angled point - 90°
Pick	130mm	Angled point - 45°

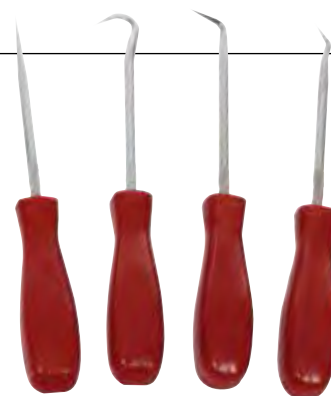

301072

Pick & Hook Set Extra Long

- Suitable for automotive, industrial and hardware applications
- Ideal for scribing, marking, picking and oil seal removal
- Manufactured from stainless steel with comfortable grip handles
- 4 piece set

Contents

Style	Length	Tip
Scratch awl	270mm	Straight point
Hook	270mm	Hook
Pick	270mm	Angled point - 90°
Pick	270mm	Angled point - 45°

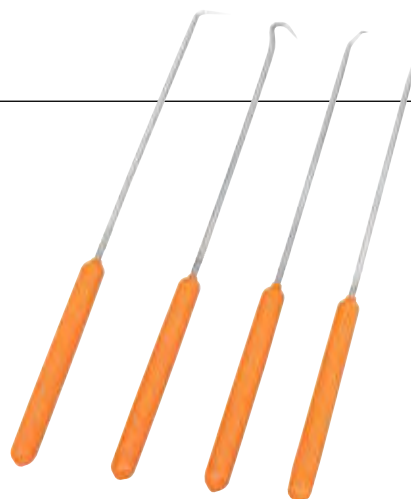

301297

Pick Set Oil Seal

- Handy double ended two piece set designed for easy removal of oil seals and O-rings
- Stainless steel shaft with plastic knurled grips
- 2 piece set

Style	Tip 1	Tip 2	Overall Length
Oil seal pick	Full hook	Straight 90°	410mm
Oil seal pick	Hook 45°	Hook 90°	410mm

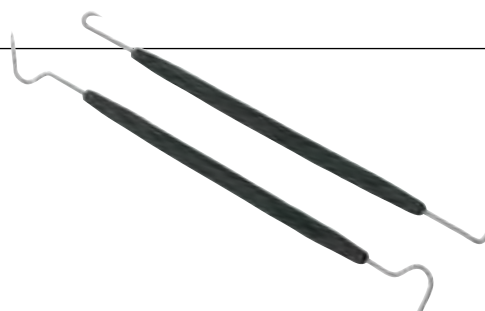



Scribers

- For use in scribing and marking
- Suitable for use on metal, glass, plastic, O-rings or ceramics
- Manufactured using solid metal construction with hardened tips for long and durable service life

Part No.	Style	Tip 1	Tip 2	Overall Length
MS7	Machinist's scriber	Straight pin	Angled pin - 90°	190mm
MSH8	HD machinist's scriber	Straight pin	Angled pin - 90°	230mm
301084	Double point scriber	Hook	Angled pin - 45°	220mm
301085	Engineer's scriber	Straight pin	Angled pin - 45°	235mm

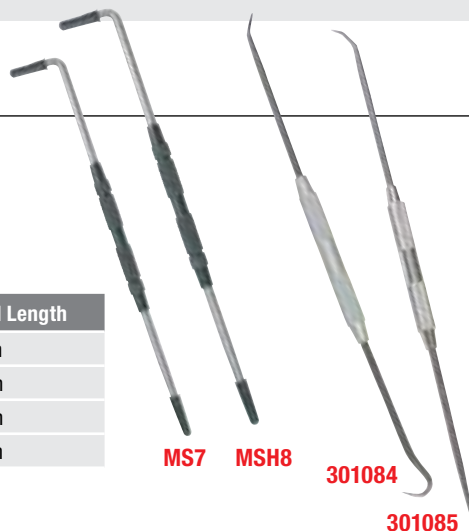

Gasket Scrapers

- For the removal of old gaskets, silicone sealants, gasket residue, carbon, ingrained dirt etc.
- Ideal tool for scraping cylinder heads, blocks, transmission cases, diff housings and metal surfaces
- Hardened and tempered carbon steel with satin chrome finish and plastic comfort grip handles

Part No.	Description	Blade Width	Overall Length
301007	Individual gasket scraper	25mm	280mm
301278	Gasket scraper set (3 piece)	20, 25, 40 (mm)	280mm



301296

Nylon Scraper Set General Purpose

- General purpose nylon blade scrapers
- Useful tools for delicate tasks such as removing badges, mouldings, decals etc.
- Eliminates potential damage and marking
- Blade widths: 20, 23, 25, 38 (mm)
- Overall length: 270mm
- 4 piece set



301651

Stainless Steel Scraper Set General Purpose

- General purpose stainless steel blade scrapers
- Ergonomic rubber comfort grip handles featuring a striking head
- Easy hang hole moulded into handle
- 3 piece set



Contents

Style	Blade Width	Overall Length
Bent chisel	30mm	220mm
Chisel scraper	50mm	220mm
Chisel scraper	30mm	220mm



Razor Style Scrapers

- Special tools designed for scraping windows and glass
- Also ideal for scraping paint from mirrors, tiles and other flat surfaces
- Supplied with blade cover
- Replaceable blades available

Part No.	Description	Blade Width	Overall Length
WSCR	Fixed body	55mm	150mm
301162	Swivel body	40mm	200mm
301247	Long reach with blades (3 x plastic & 3 x metal)	40mm	280mm

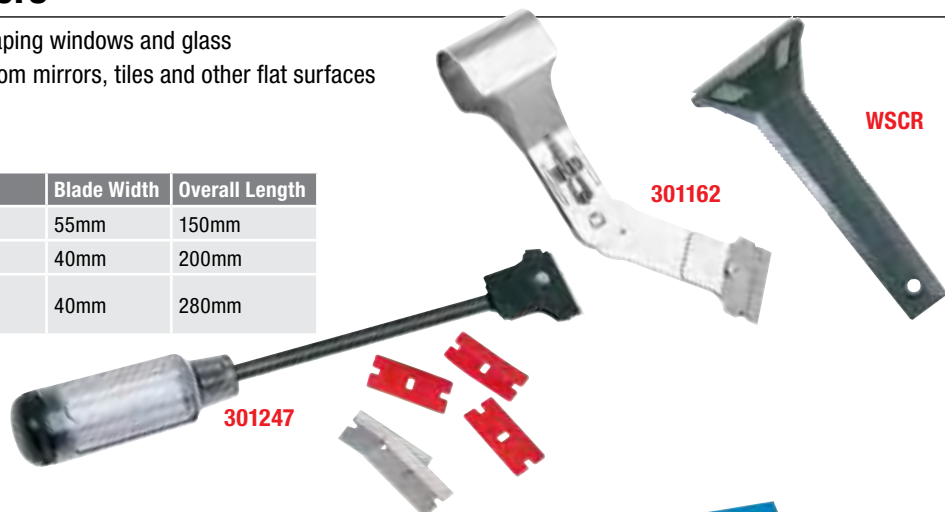

Scraper Razor Blades

- Suitable for all Toledo razor scrapers
- Stainless steel blades are sharp and durable
- Plastic razors are ideal for damage free removal in applications such as painted surfaces etc.

Part No.	Material	Blade Width	Packing
301250	Stainless steel	40mm	2 Boxes (12 razors/pack, 6 packs/box)
301248	Stainless steel	40mm	100 Razors/pack
301249	Plastic	40mm	100 Razors/pack



Profile Gauges

- Sliding plastic fingers provide a solid contour around an object to provide a contour of the desired shape
- Quick and easy way to copy profiles
- Ideal for hardware, industrial and DIY use
- Available in two lengths which can be connected together to provide a combined length
- Features graduated main body and magnets
- Manufactured from durable plastic

Part No.	Size
301890	130mm
301891	260mm

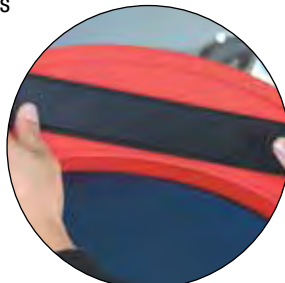

Easily contours around objects for cutting and shaping

301165

Sanding Block

- Sanding block with spring loaded clips which hold paper firmly in place and also allow for quick paper installation and removal
- Manufactured from ABS plastic making it light weight and also extra strong
- Pad size: 106 x 212mm





SCREWDRIVERS

Screwdrivers Extra Long

- Manufactured from hardened chrome vanadium steel with comfort grip handle
- Extra long shaft allows reach to confined spaces and areas with restricted access

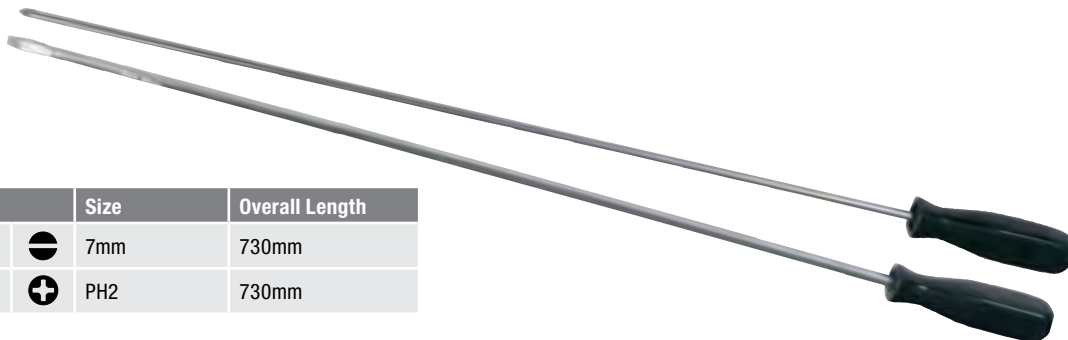

Part No.	Style		Size	Overall Length
301090	Slotted	☉	7mm	730mm
301091	Phillips	⊕	PH2	730mm

301649

Screwdriver Multi-Bit Flexible

- Solid metal construction with plastic comfort grip handle
- Multi bit design containing Slotted, Phillips and Pozidriv bits
- Adjustable telescopic flexible shaft allows access to confined spaces and areas with restricted access
- Overall length 270–430mm



Contents

Bit Type		Size
Slotted	☉	SL4 & SL6
Phillips	⊕	PH1 & PH2
Pozidriv	⊛	PZ1 & PZ2

301089

Screwdriver, Light & Pick-Up Tool Multi-Bit Magnet

- Metal construction with plastic comfort grip handle
- Multi bit design containing Slotted, Phillips and Six Point “Torx” bits
- Features LED lights incorporated into the handle assembly and hollow shaft with magnetic pick-up tool
- Overall length: 270–610mm (magnetic pick-up tool only)
- Requires spare batteries (not included)



Contents

Bit Type		Size
Slotted	☉	3/16” & 1/4”
Phillips	⊕	PH1 & PH2
Torx	⬠	T15 & T20



301163

Screwdriver Set Stubby

- Stubby size allows access in confined spaces
- Contains Slotted and Phillips head styles
- Manufactured from alloy steel with easy grip handle
- 4 piece set

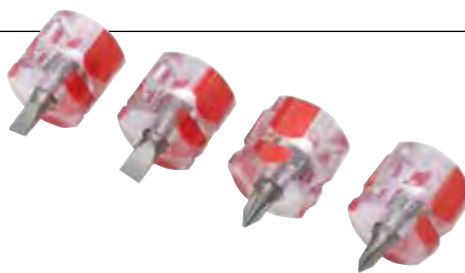

Contents

Bit Type		Size	Overall Length
Phillips	⊕	PH1, PH2	45mm
Slotted	⊖	SL5, SL6	45mm

301710

Screwdriver Set Precision Hex

- Precision hex screwdriver design with knurled shaft and swivel head for single handed operation
- For the removal and installation of small hex screws, bolts and nuts
- Sizes 2.5–5.5mm. Overall length: 110mm
- Manufactured from alloy steel with hardened hex drivers
- 8 piece set supplied in plastic storage case



Contents

Part No. (Spare)	Size	Part No. (Spare)	Size
301711	2.5mm	301715	4.0mm
301712	3.0mm	301716	4.5mm
301713	3.2mm	301717	5.0mm
301714	3.5mm	301718	5.5mm

301095

Impact Driver Set Professional

- Converts hammer impact to powerful torque ideal for loosening screws, nuts and bolts
- Complete with a metal storage case
- Manufactured from chrome-moly steel, heat-treated and chrome plated
- Includes impact driver and 4 bits



Contents

Bit Type	Size
Phillips	⊕ PH2, PH3
Slotted	⊖ SL9, SL11

Nut Driver Sets

- For use on small nuts or bolts where quick installation or removal is required
- Features ergonomic plastic handles with slip resistant inserts to allow greater torque
- Manufactured from chrome vanadium steel with chrome plated finish
- 9 piece kits available in metric and SAE configurations

Part No.	Style	Sizes
321007	Metric	4, 5, 5.5, 6, 7, 8, 9, 10, 11, 12 (mm)
321008	SAE	3/16", 7/32", 1/4", 9/32", 5/16", 11/32", 3/8", 7/16", 1/2"

